

3-DIMENSIONAL ULTRASONIC ANEMOMETER

Model : WA-790

*The first step of the air flow monitoring
in a clean room starts by always using WA-790 !*



For the reality grasp of the air flow in a clean room.

An accurate breeze measurement is achieved.
Three-dimensional structure of the air flow is made visible.

For the planning and the evaluating on air flow in a clean room.

Proper arrangement of the device is supported.
The relation between the product quality and the air flow is offered.

Features

◆ **Measurement of 3-Dimensional Wind Velocity Components**

With the combination of three axis of x, y and z, you can get very precise wind speed & direction.

◆ **Measurement of 0m/sec Wind Velocities and 0.5 sec in Response**

Free from self heating, capable of measuring wind speed from 0m/sec.

◆ **Measurement of Turbulent Airflow**

Capable of measuring the turbulent airflow caused by the facilities, in the clean room.

◆ **Fluctuating Temperature/Humidity Effect Free Observation**

Theoretically zero error, free from the change in temperature.

About WA-790

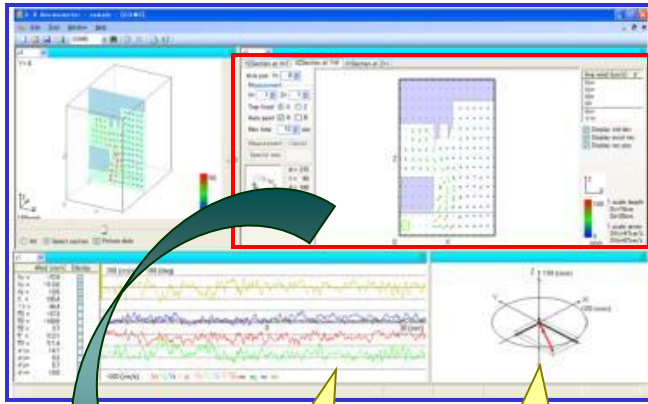

Raw data

Vector view

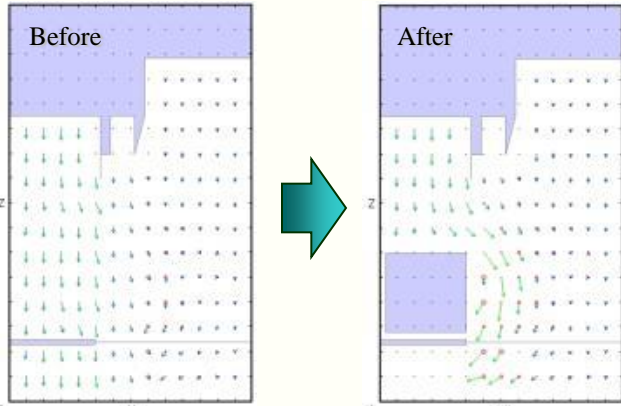

Get the images of air flow with you PC.

Variety of data processing functions

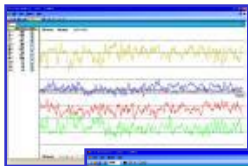

- Air flow monitoring, data logging and playback.

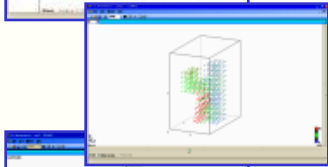

- Multi points observation. Multi angles viewing.



- Three-dimensional display of the air flow distribution.

Would you like to increase the efficiency of measuring air flow.

Specifications

Measurement mode : Time sharing transmission/reception switching type ultrasonic pulse emission
 Measurement range : 0 ~ 10 m/s
 Accuracy : $\pm(2\%+0.02\text{m/s}$ of absolute value of indicated value)
 (At main wind direction after measure zero adjustment)

Resolution : 0.005m/s (wind)
 Power source : AC100~240V $\pm 10\%$

『Attached software (WASP-007N)』

OS : Windows 7, 10

Communication : USB port

- Real-time monitoring
- Change of wind velocity is displayed on the pen plotter screen
- Data logging and playback
- Three-dimensional display of air flow
- Observing of multi points and Viewing of multi angles
- Data save in JPEG and AVI

Dimensions

● WA-790 Main Unit

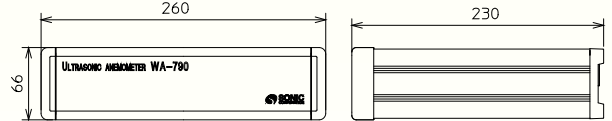

● USC-71 Signal Converter

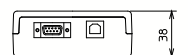
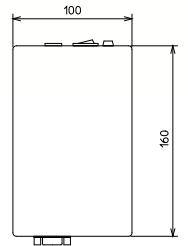
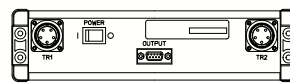

● TR-90T Probe

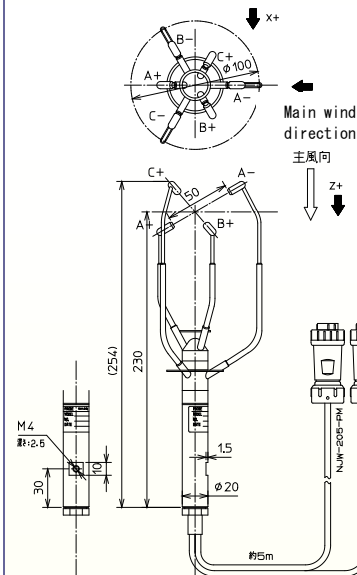

● Fixture

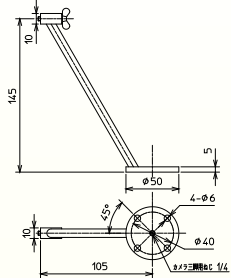

CAUTION FOR SAFETY : Please read surely INSTRUCTION MANUAL before operating

● Specification is subject to change without prior notice for improvement.